



ASSEMBLY INSTRUCTIONS

■ HIDDEN GUTTER SYSTEM



KROP

SYSTEM RYNNY UKRYTEJ

STAL/PVC



KROP[®]

SYSTEM RYNNY UKRYTEJ

STAL/PVC

	PAGE
DESCRIPTION OF THE HIDDEN GUTTER SYSTEM COMPONENTS	2
Tools required for assembly	3
INTRODUCTION	3
1. Preparation of the roof structure	4
2. Preparation of the boards for mounting the system	4
3. Preparation of the hole for the outlet	5
4. Protection of the structure with an additional membrane	5
5. Preparation of the hole in the verge trim	5
6. Installation of the verge trim to the MFP board	6
7. Installation of fascia brackets	7
8. Installation of PVC gutter brackets	7
9. Installation of the PVC outlet	8
10. Installation of the PVC bottom	8
11. Installation of the fascia	9
12. Installation of the fascia connector	10
13. Installation of the plug	10
14. Installation of the drain riser	11
15. Installation of the connector with gasket	11
16. Installation of the pit	12
17. Installation of the drain riser	12
18. Recommended installation of snow guards	12
19. Installation of the KROP HGS for a roof with eaves (KROP PVC)	13
20. Installation of the KROP HGS for a roof with eaves (KROP PVC with a square outlet)	13
21. Installation of the square pipe	14
22. Completion of installation	15

DESCRIPTION OF THE COMPONENTS OF THE KROP HIDDEN GUTTER SYSTEM

STAL/PVC

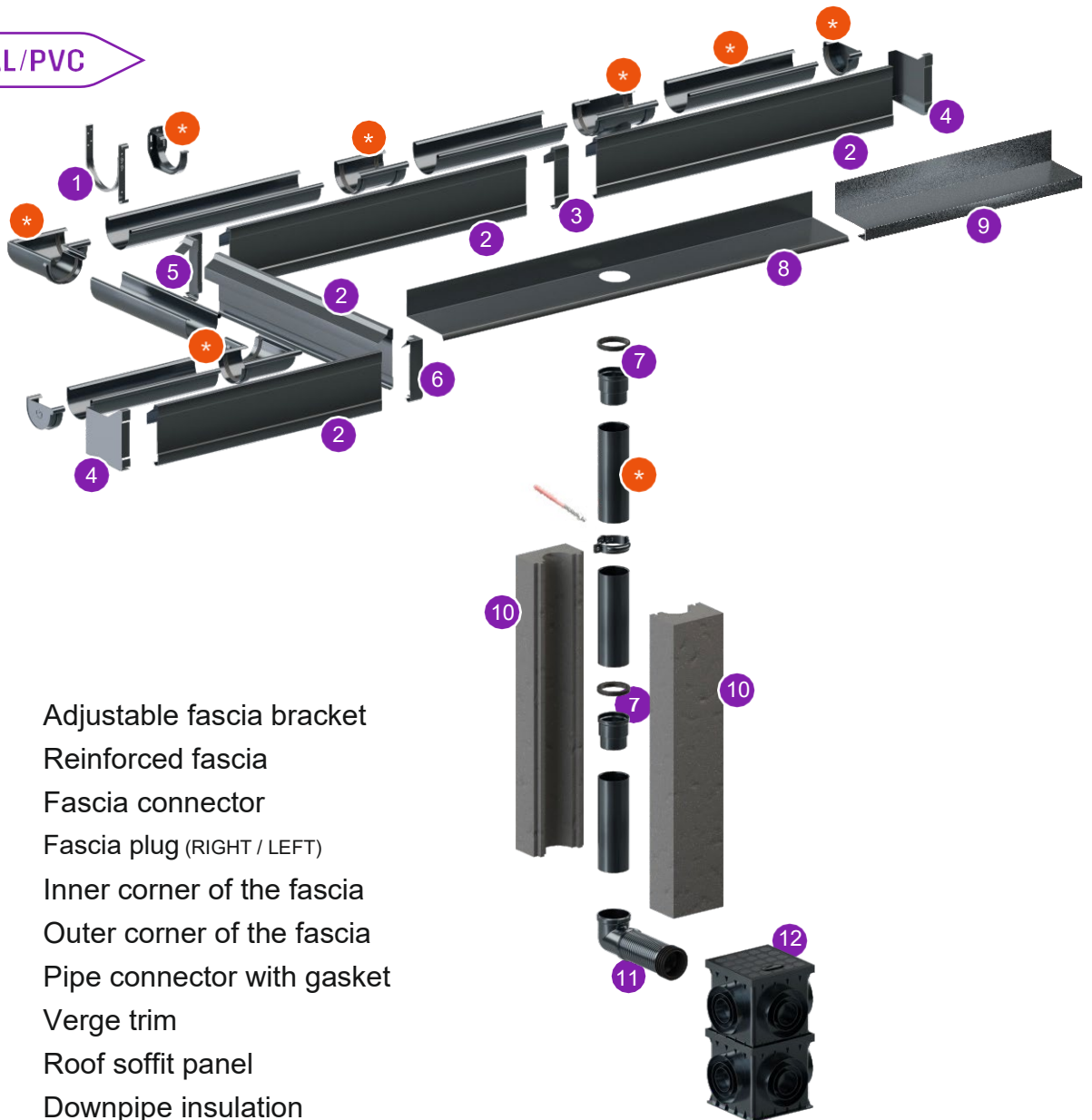

- 1 Adjustable fascia bracket
- 2 Reinforced fascia
- 3 Fascia connector
- 4 Fascia plug (RIGHT / LEFT)
- 5 Inner corner of the fascia
- 6 Outer corner of the fascia
- 7 Pipe connector with gasket
- 8 Verge trim
- 9 Roof soffit panel
- 10 Downpipe insulation
- 11 Flexible elbow
- 12 Inspection pit

* KROP PVC gutter system

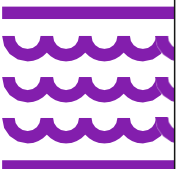

Tools required for assembly



Circular saw
for wood



Screwdriver



Sheet metal
shears



Roofing
hammer



Level

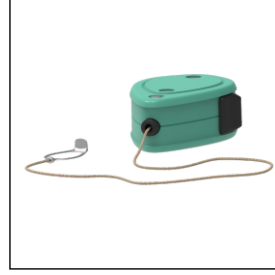

Chalk line



Tape measure

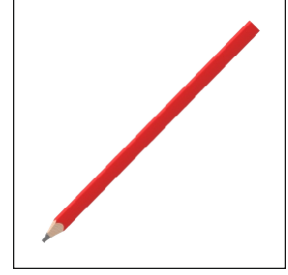

Pencil

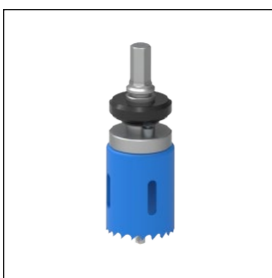

Hole saw



Jigsaw



Gasket spray

INTRODUCTION

The roof for eaveless systems should be prepared in advance, at the design stage. The bottom chord should be set back as far as possible from the external surface of the wall so that the most efficient thermal insulation can be used between the bottom chord and the base of the Hidden Gutter System (HGS). If the building is already designed, inform the developer and roof truss contractor that it might be necessary to move the bottom chord.

1. Preparation of the roof structure



Prepare the rafters as necessary to properly install the HGS. The target thickness of the house insulation is **200 mm**, so the rafters should be cut so that their edges are set back from the wall by **15 mm**. The vertical dimension of the bottom chord cross-section should be high enough to allow the external wall insulation to be connected to the attic insulation (traditional under-truss or rafter insulation) after the base is installed. A second solution may be to design a set-back ring beam.

2. Preparation of the boards for mounting the system



Use **25 mm** thick MFP board to make the correct base for the system. Using board sections with a width of: VERTICAL **from 205 mm to 215 mm** and HORIZONTAL **215 mm** (or individually adjusted to the height calculated with the calculator), make a L-shaped structure, placing the **205-215 mm** wide wThe joints between the board should be arranged so that the end of the vertical board does not overlap with the end of the horizontal board. Connect the boards from underneath with screws, remembering to level them beforehand. Mount the ready base to the pre-cut roof rafters with screws.

CALCULATE THE DATA FOR CORRECT GUTTER INSTALLATION - CALCULATOR

To make it easier to determine the base mounting position, we have developed a calculator available at WWW.KROPSYSTEM.EU, which will easily determine the **Z** distance, i.e. the height between the board edge and the top edge of the counter-batten.

To prevent damage to the fascia from sliding snow, ensure that the roof extension is above the top edge of the fascia. It is recommended to use snow guards.

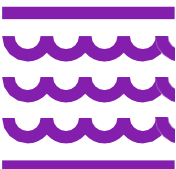

3. Preparation of the hole for the outlet

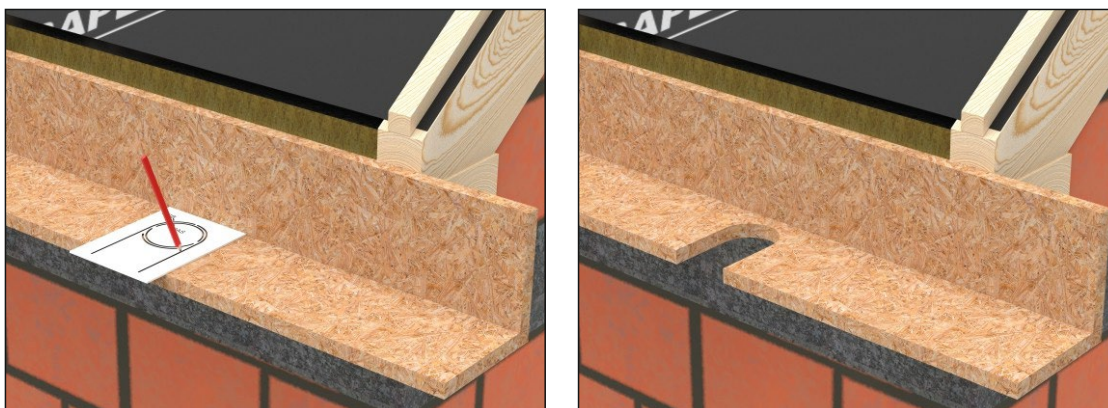

In the area where the downpipe outlet is to be installed, make a hole using a ready-made jig which facilitates outlining the hole in the MFP board and the verge trim. Cut the hole with a hole saw and jigsaw.

Download the jig from the website: WWW.KROPSYSTEM.EU

4. Protection of the structure with an additional membrane

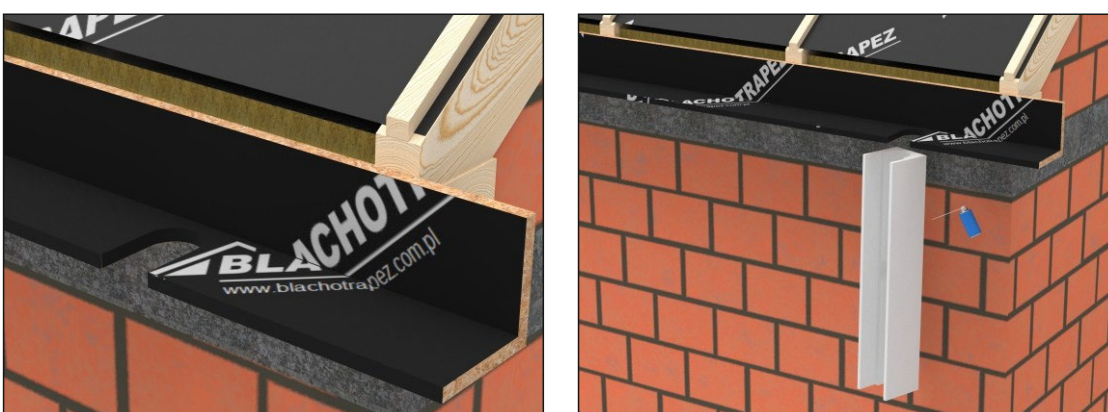

Line the entire structure with a dedicated vapour-permeable membrane from Blachotrapez. The membrane should be fixed to the board using staples and adhesive tape for joining the membrane. Install the downpipe insulation using polystyrene adhesive mortar, remembering to first position the dowels for the steel clamps for PVC. **For the detailed installation of the drain riser, see section: 14.**

5. Preparation of the hole in the verge trim

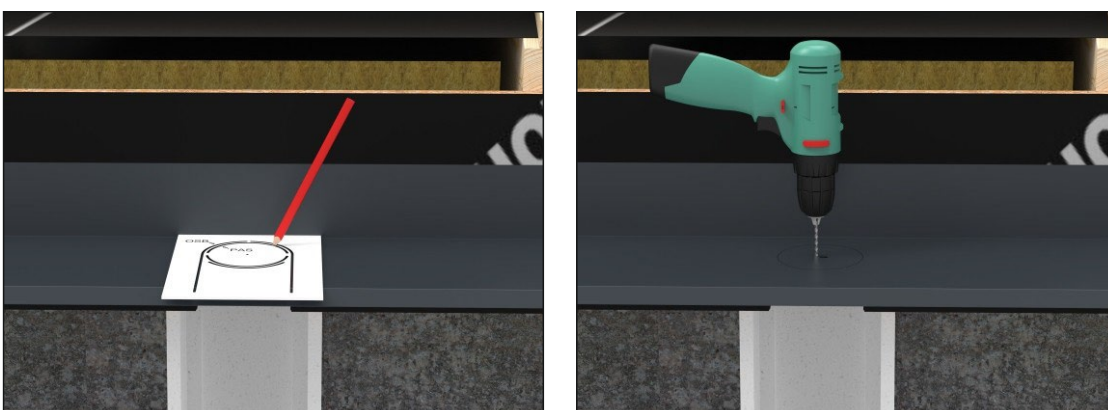

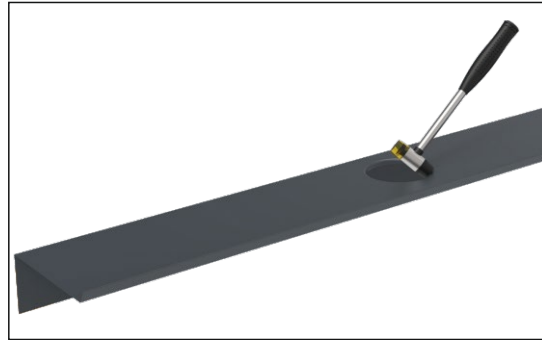
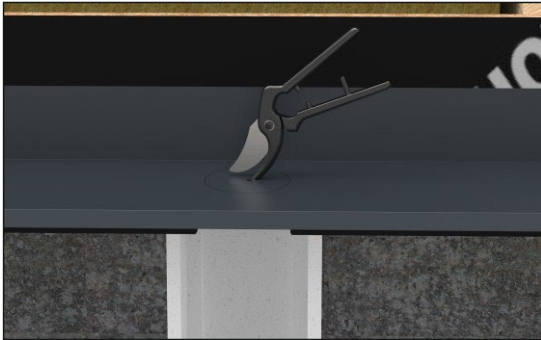

To make the hole for the outlet in the verge trim, determine its position using the same jig as for cutting the hole in the base. The hole should be outlined according to the smaller inner circle marked PAS. To cut the hole, use a screwdriver, with which you can pierce the centre of the hole, and then use roofing shears to cut out the outlined circle. In order to prevent condensation from entering the drain pipe insulation, it is very important to trim the edge of the circle towards the top of the verge trim.

6. Installation of the verge trim to the MFP board



Mount the verge trim to the MFP board with stainless steel screws. Make sure that the screws are at least **10 mm** from the edge of the board. The verge trim has a slope of **3°** which results in a distance of **10 mm** between the horizontal part of the trim and the MFP board. For proper drainage of condensation, we recommend maintaining the factory slope of the verge trim.

The verge trim can be joined in several ways without the use of glue/sealant. A latch or craft hem connection can be used.

Make the vertical eave sheets and adjust them individually to the roof. The membrane should be attached to this sheet with double-sided adhesive tape.

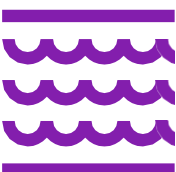

7. Installation of fascia brackets



The KROP Hidden Gutter System has been designed so that when the fascia is fitted to the brackets, the slope of the **PVC 130 gutter** inside the system is concealed. The installation of the entire system starts with the positioning of the first fascia bracket at a distance of **10 cm** from the side edge of the MFP board and flush with its top edge. Mount the remaining fascia brackets at a maximum spacing of **every 50 or 66 cm** (depending on the roof

pitch), while keeping the bracket level with the top edge of the MFP board. Bear in mind that the level of the fascia is dependent on the correct positioning of the brackets. If you have problems with the levelling of the brackets, you can additionally adjust the level of the bracket mandrel by means of longitudinal holes, the so-called "beans". With a hip roof, the positioning of the brackets can be determined according to individual arrangement, observing the permitted maximum spacings. When installing the fascia brackets, ensure the airflow required to ventilate the slope. The gap between the fascia and the verge trim should be **1-1.5 cm**.

8. Installation of PVC gutter brackets



Highest mounting point of the bracket.



Lowest mounting point of the bracket with the outlet.



Lowest mounting point of the bracket with the outlet.

The furthest gutter brackets from the outlet (the brackets at the highest mounting point) **are mounted at the height of the first fascia bracket hole.**

The maximum spacing for gutter brackets is **60 cm**. PVC gutter brackets with the lowest mounting point are installed flush with the second hole of the fascia bracket. The maximum slope that can be applied to a hidden gutter system is **up to 3%** (3 cm per 10 m of gutter).

9. Installation of the PVC outlet



When installing the KROP PVC Gutter System, first position the outlet in the hole and then install the gutter.

10. Installation of the PVC bottom



Before fitting the bottom, it should be sprayed with SPRAY for gaskets. To provide additional sealing, it is recommended to use silicone sealant where the bottom joins the gutter.

Further accessories are assembled in accordance with the assembly instructions of the KROP PVC GUTTER SYSTEM available on the website:

WWW.KROPSYSTEM.EU

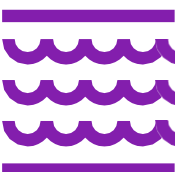

11. Installation of the fascia



To avoid a clash between the fascia and the PVC bottom, the end of the fascia should be cut to a distance of 15 mm. Put the fascia on from the top, and click its bottom against the lower part of the bracket.



Before clicking the fascia into the brackets, check that the lower part of the fascia is well fixed in the bracket mandrel.

12. Installation of the fascia connector



Connect the fascia with a dedicated connector by sliding the connector in or clicking it.

At this stage of installation, we recommend installing a roof-edge flashing that is suitably matched to the KROP Hidden Gutter System.

Installation of the roof-edge flashing.

13. Installation of the plug



Finish the fascia with a dedicated plug by sliding it on.

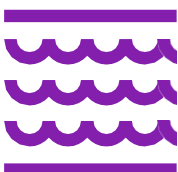

14. Installation the drain riser



A maximum spacing of **2 m** between dowels is recommended.



Mount a polystyrene moulding onto suitably spaced dowels and screw steel clamps to the PVC pipe.

15. Installation of the connector with gasket



Lubricate the gasket with silicone to make it easier to install the top of the connector with the outlet. Before fitting the pipe onto the connector, lubricate its bottom part with an aggressive adhesive for PVC. The gasket guarantees correct dilatation of the downpipe. Connect the downpipes also using the connector with a gasket, following the same procedure as when installing the connector with the outlet.



16. Installation of the pit

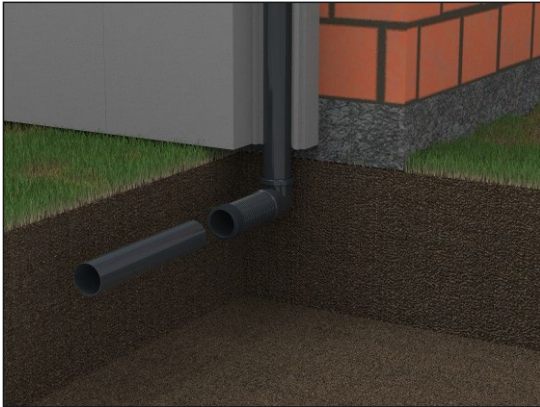

In order to drain rainwater into the stormwater drainage system, construct a drainage and inspection system that includes a flexible elbow and an inspection pit with superstructure. The inspection pit, with a special grating between the base and the superstructure, serves to catch debris that may block the flow of rainwater.

17. Installation of the drain riser

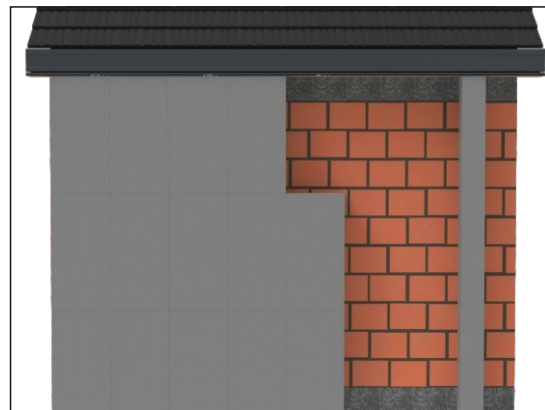

Once the downpipes have been placed in the insulation moulding and the steel clamps have been tightened, close the whole system with the cover of the polystyrene moulding. Glue it together with polystyrene gun glue or low-expansion mounting foam. Carry out further work according to the guidelines of insulation and plaster manufacturers.

18. Recommended installation of snow guards

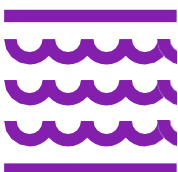
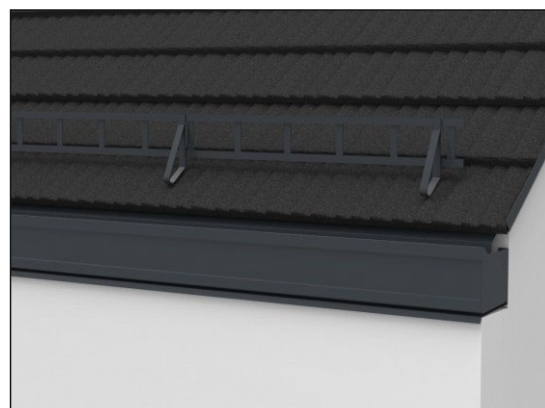

19. Installation of the KROP HIDDEN GUTTER SYSTEM for a roof with eaves (KROP PVC Gutter System)

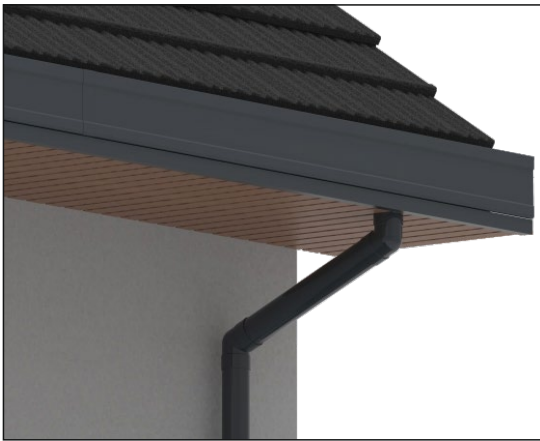

In order to make the correct base for the KROP HIDDEN GUTTER SYSTEM for a roof with eaves, use the same board design as in **item 2. Preparation of the boards for installation.** Using timber laths **min. 25 x 50 mm**, make a support structure for the KROP roof soffit, with a spacing of no more than **40 cm** and place them on the same level as the bottom board of the structure. For this installation variant, it is recommended to install a ROOF SOFFIT PANEL whose “J”-shaped profile allows for easy attachment of the roof soffit.

20. Installation of the KROP HIDDEN GUTTER SYSTEM for a roof with eaves (KROP PVC Gutter System with a square outlet)

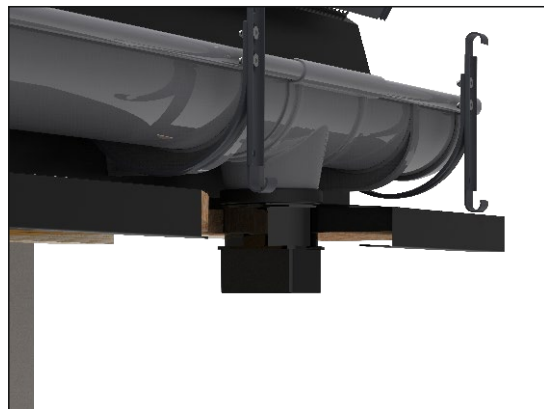

To connect the 130 PVC outlet to the KROP PVC square pipe, use the 90/80x80 mm adapter, which is the connecting element between the 130 PVC semi-circular system and the 80x80 PVC square pipe. Before the assembly, spray the adapter gasket with gasket silicone (SPRAY).



Then, for the roof variant with eaves, use a square elbow and a section of square pipe cut to the required length.



When installing a drain riser straight with the outlet, connect the outlet using an adapter and a square connector.

21. Installation of the square pipe



The installation of the drain riser starts with the positioning of the dowels in the façade. Adapt the dowels to the thickness of the building insulation. KROP offers dowels for steel pipe clamps in the following dimensions: 12x100, 12x160, 12x200, 12x260, 12x300.

Screw the steel clamps onto the dowels mounted to the façade, maintaining a spacing of max. 1.8 m. Tighten the clamps on the pipe, maintaining the appropriate dilatation of the pipe.

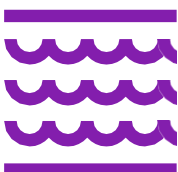



Connect the pipes placed in the clamps using the square connector.



You can match the colour of the square pipe with the colour of the fascias available, i.e. RAL 9005 BLACK and RAL 7016 GRAPHITE.

21. Completion of installation

You can drain water through the square pipe into the sewer system by using a universal sedimentation tank. For this purpose, cut a suitable hole in the sedimentation tank for the 80x80 mm square pipe.

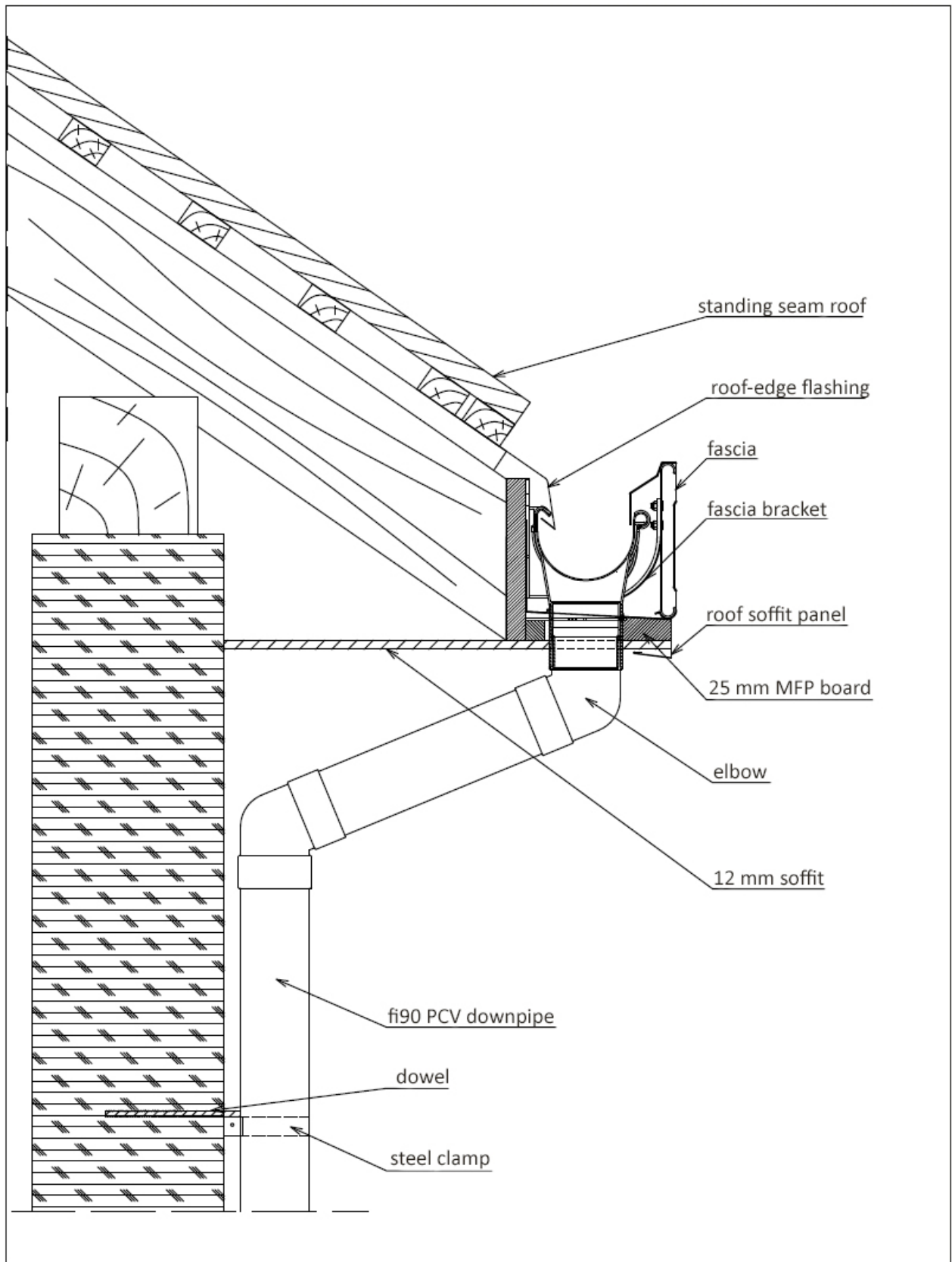

KROP.



Traditional craftsmanship in a modern form

Installation requires expertise, specialist knowledge, and experience. These instructions are illustrative and do not release contractors from their obligation to comply with the principles of the roofing trade and standards.

The installation methods shown in these instructions are general guidelines. The required installation method may differ from that indicated in the instructions depending on the type of roof or regional solutions. To use the general instructions and guidelines for installation, follow the designer's guidelines or contact our technical support department. Experienced contractors have individual solutions that BLACHOTRAPEZ accepts.

More details at **KROP** outlets
and on the website:

WWW.KROPSYSTEM.EU

Manufacturing plant
Polanka 323, 32-400 Myślenice
Tel.: +48 12 37 31 666

Blachotrapez Sp. z o.o.
ul. Kilińskiego 49a
34-700 Rabka Zdrój

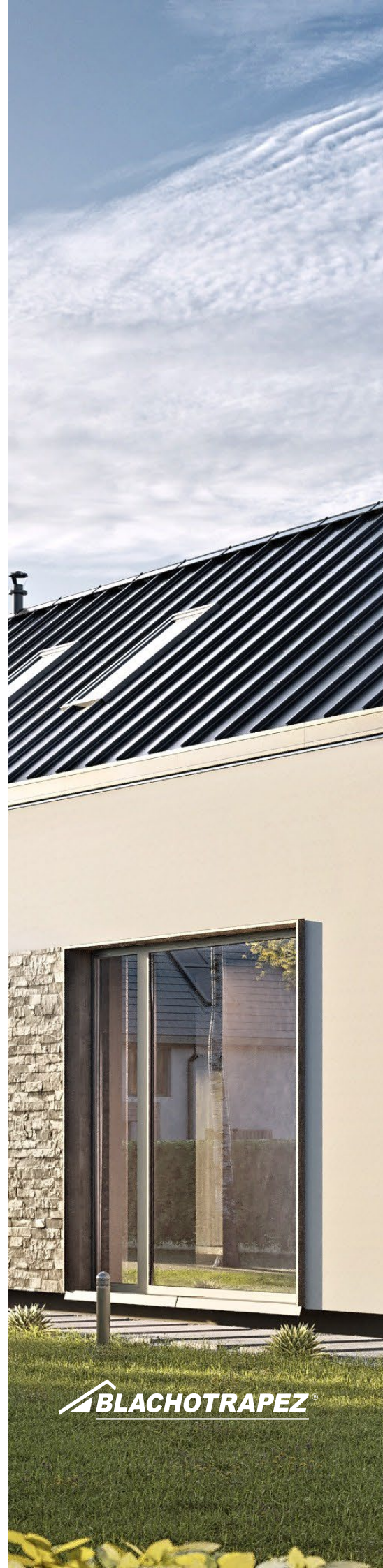

BLACHOTRAPEZ